



3700H & 3700-2H

FULLY OILED CHAIN STITCH SEWING MACHINE

SINGLE OR DOUBLE NEEDLE SEWING MACHINE
WITH DOUBLE TRANSPORT FROM ABOVE AND BELOW

- DESIGNED FOR BIG BAG PRODUCERS, WITH FILLER CORD FEED FROM ABOVE AND BELOW
- TO BE USED FOR SEWING LIGHT AND MEDIUM WORK
- USED FOR SEWING BAFFLE PANELS, TOP AND BOTTOM SPOUTS AND IN THE PREPARATION OF WEBBINGS TO BE SEWN



3700H & 3700-2H Series
Pneumatic Presser Foot System



ISO 9001:2000





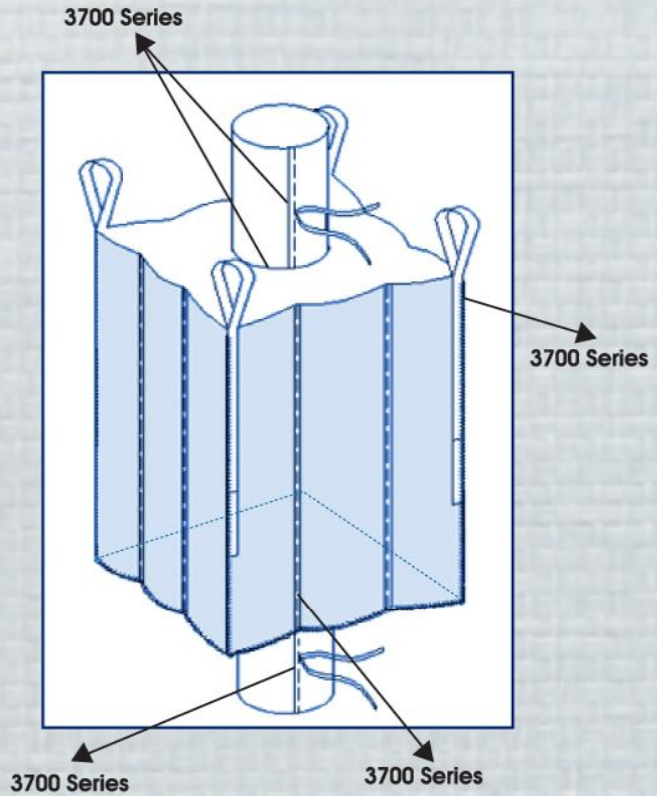





3700H & 3700-2H FULLY OILED CHAIN STITCH SEWING MACHINE



FEATURES

- Standard filler cord feed from above and below.
- Heat cutting can be mounted if desired.
- Has a low spare parts consumption.
- Has a strong transport system.
- A perfect regular and constant pull can be achieved with thick or thin fabric with or without a filler cord because of a successful feed dog and presser foot system.
- A bearing system has been added to the feed dog transport lever.
- It is faster and has a longer life than similar machines in the same class.

TECHNICAL SPECIFICATIONS

		Single Needle 	Double Needle 
Needle (200-230-250)		UY 143 GS	UY 143 GS
Threads		2	4
Stitch Spacing		5-10 mm	5-10 mm
Distance Between Two Needles		7	7
Presser Foot Lift Distance		10	10
Maximum Speed (RPM)		2600	2600

ORSAN OPS MAKİNE SANAYİ TİCARET LİMİTED ŞİRKETİ

MARMARA SANAYİ SİTESİ P-BLOK NO: 413 - 414 İKİTELLİ / İSTANBUL / TÜRKİYE

TEL: +90 212 472 08 78 / 79 / 80 FAX: +90 212 472 08 81

www.orsanops.com info@orsanops.com